

Fire Product

“Galford” Fire product advantage





- “Certifire” certification from UK Warrington, Certifire NO. CF5632
- BS EN test report for 30' 60' and 120' for wooden door and steel door
- Expansion rate up to 30 times
- Totally not affected by water and damp
- Laser print Logo on product
- Co-extrusion or Triple extrusion for intumescent , casing and flipper.
- For fire & smoke seal , pile steady in position , can not be moved.

“Galford” Fire & acoustic seal

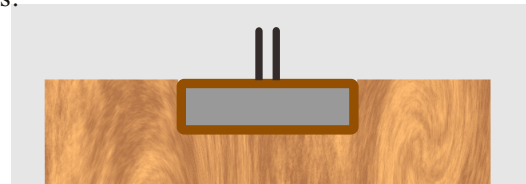
Property

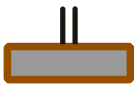
- Triplex-extrusion of core, case and rubber ensure rubber does not taken off.
- Varies of special profiles are available for customers' demands.
- 30 times expansion.
- The lower expansion temp.is 180°Cto 200°C.
- Co-extrusion to ensure the core material does not fall off.
- “Certifire” of Warrington , BS EN 1634-1 test report.
- Online printing logo and batch number on product.

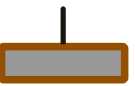

Profile Size (mm)	Part Number				
					
10×4	YZ1024		YZ1024-2	YZ1024-3	YZ1024-4
15×4	YZ1524	YZ1524-1	YZ1524-2	YZ1524-3	YZ1524-4
20×4	YZ2024	YZ2024-1	YZ2024-2	YZ2024-3	YZ2024-4
20×6	YZ2026	YZ2026-1	YZ2026-2	YZ2026-3	YZ2026-4
25×4	YZ2524	YZ2524-1	YZ2524-2	YZ2524-3	YZ2524-4
25×6	YZ2526	YZ2526-1	YZ2526-2	YZ2526-3	YZ2526-4
30×4	YZ3024	YZ3024-1	YZ3024-2	YZ3024-3	YZ3024-4
38×4	YZ3824	YZ3824-1	YZ3824-2	YZ3824-3	YZ3824-4

Colour:      

RAL8024 RAL9003 RAL9004 RAL3020 RAL9010 Pantone8C

Fire Product

“Gallford” Rigid fire seal

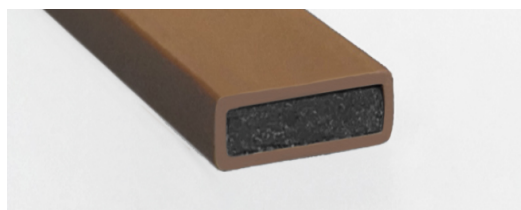

Property

- 30 times expansion
- The lower expansion temp. is 180°C to 200°C
- Co-extrusion to ensure the core material does not fall off.
- “Certifire” approved by Warrington UK, BS EN 1634-1 & BS476 20-22&3C&GB test reports
- Online printing logo and batch number on product

Part Number	Profile Size (mm)	Packing (carton)
YZ1004	10×4	400pcs×2.1m
YZ1503	15×3	280pcs×2.1m
YZ1504	15×4	280pcs×2.1m
YZ2003	20×3	200pcs×2.1m
YZ2004	20×4	200pcs×2.1m
YZ2006	20×6	160pcs×2.1m
YZ2009	20×9	90pcs×2.1m
YZ2504	25×4	160pcs×2.1m
YZ2506	25×6	125pcs×2.1m
YZ3004	30×4	140pcs×2.1m
YZ3006	30×6	90pcs×2.1m
YZ3804	38×4	120pcs×2.1m

Colour:      

RAL8024 RAL9003 RAL9004 RAL3020 RAL9010 Pantone8C

Fire Product

“Gallford” Rigid fire & smoke seal

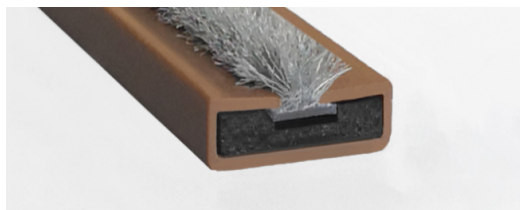

Property

- Online insert pile with glue. pile does not taken off.
- 30 times expansion
- The lower expansion temp. is 180°C to 200°C.
- Co-extrusion to ensure the core material does not fall off.
- “Certifire” of Warrington, BS EN 1634-1 test report.
- Online printing logo and batch number on product.

Part Number	Profile Size (mm)	Packing (carton)
YZ1014	10×4	250pcs×2.1m
YZ1514	15×4	200pcs×2.1m
YZ2014	20×4	150pcs×2.1m
YZ2514	25×4	100pcs×2.1m
YZ2516	25×6	80pcs×2.1m
YZ3014	30×4	60pcs×2.1m

Colour:



RAL8024



RAL9003



RAL9004



RAL3020



RAL9010



Pantone8C

Fire Product

“Galford” Flexible fire seal

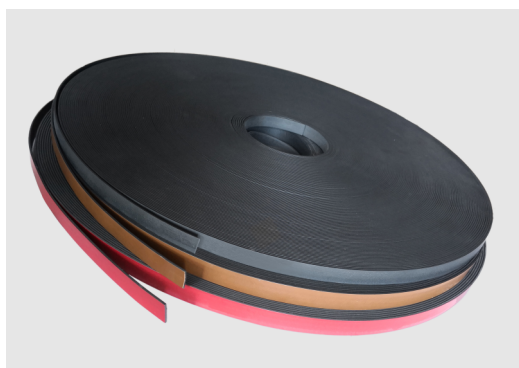

Property

- Intumescent material covered with flexible PVC skin which enhances appearance and is available in different colours
- Cutting from 650mm fire sheet, can be varies width of seal, 1mm, 1.5mm and 2mm thickness available
- Co-extrusion seal also available

Part Number	Profile Size (mm)	Packing (carton)
RM0706	7×6	100m/coil
RM0802	8×2	100m/coil
RM1002	10×2	100m/coil
RM1004	10×4	100m/coil
RM1302	13×2	100m/coil
RM1502	15×2	100m/coil
RM1802	18×2	100m/coil
RM2002	20×2	100m/coil
RM2502	25×2	100m/coil
RM3002	30×2	100m/coil
RM4002	40×2	100m/coil
RM5002	50×2	100m/coil
RM6002	60×2	100m/coil

The thickness of cutted fire strips have 1 mm , 1.5mm ,2mm .
The thickness of extruded fire strips are customized available .
The width of cutted fire strips are customized available .
(Max. width is 640mm)

Colour:



RAL8024



RAL9004



RAL3020

Above three colors for cutted fire strips . The color of extruded fire strips can be customized .

Fire Product

“Gallford” Special fire seal

Property

- Intumescent material covered with rubber seals,
- Double function with fire & weather seal both
- Easy application, suitable for fitting to rebates in wooden door / steel door leaf or frame.
- Made by customer's requirement

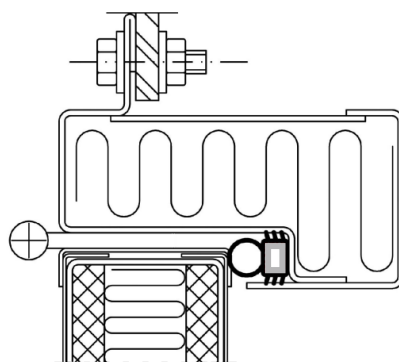

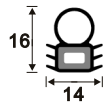
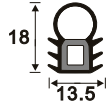
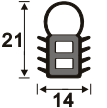
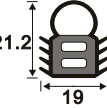
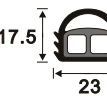
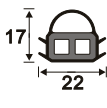
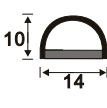
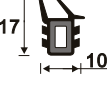
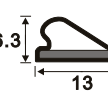
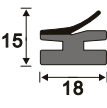
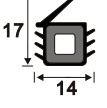
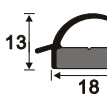
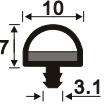
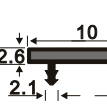
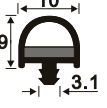
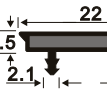
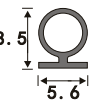
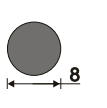
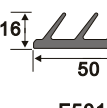
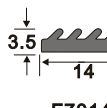
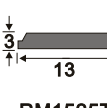
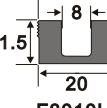
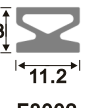
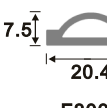
 <p>F8967</p>	 <p>F8962</p>	 <p>F8282</p>	 <p>F8966</p>	 <p>F8383</p>	 <p>F8965</p>
 <p>F8969</p>	 <p>F8007-4</p>	 <p>F1306T</p>	 <p>F8006-3</p>	 <p>F8968</p>	 <p>FW1813</p>
 <p>FW1007</p>	 <p>FW2026</p>	 <p>FW1009</p>	 <p>FW2203</p>	 <p>F6085</p>	 <p>F0800R</p>
 <p>F5016</p>	 <p>F7014</p>	 <p>RM1525T</p>	 <p>F8010U</p>	 <p>F8002</p>	 <p>F8001</p>

Fire Product

“Galford” Fire sheet

- Made by intumescent material, Expansion rate with 5 times, 15times and up to 25 times.
- Max.width 640mm, standard thickness 1mm,1.5mm and 2mm.
- Suitable for inner lining of fire door panels, filling cabinets and storage boxes, and electrical boxes.
- With or without adhesive tape.

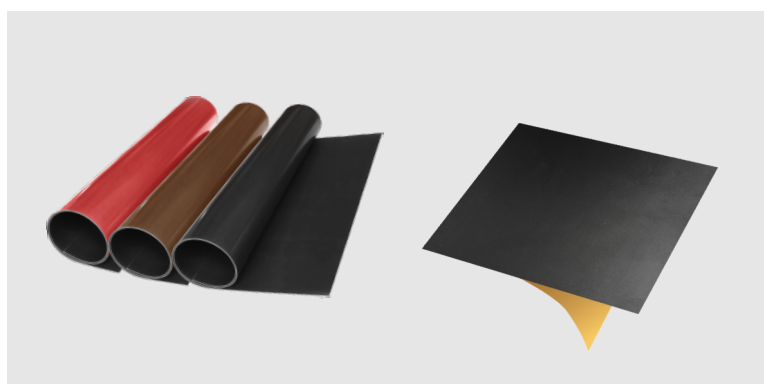

Part Number	Width (mm)	Thickness (mm)	Expansion Ratio	Length (coil)
FS64002	640	2	30、 15、 5	100m&Customized
FS64015	640	1.5	30、 15、 5	100m&Customized
FS64001	640	1	30、 15、 5	100m&Customized
Cutting arbitrary shape, length and width				

Colour:



RAL8024



RAL3020



RAL9004

Fire Product

“Gallford” Fire Lock Kit & Hinge Pad

- Made by intumescent material, Expansion rate with 5 times, 15times and up to 25 times.
- Thickness with 1mm, 1.5mm and 2mm.
- Die cutting of pads for lock kit and hinge pad , door closers etc.
- With or without adhesive tape.



Fire Product

“Galford” 60 minutes fire glazing seal system

- Three parts system, consists 2 glazing seals + 1 aperture liner.
- Suitable for different thickness glass.
- The integral fins adjust good tolerance and give sufficient compression for glass.

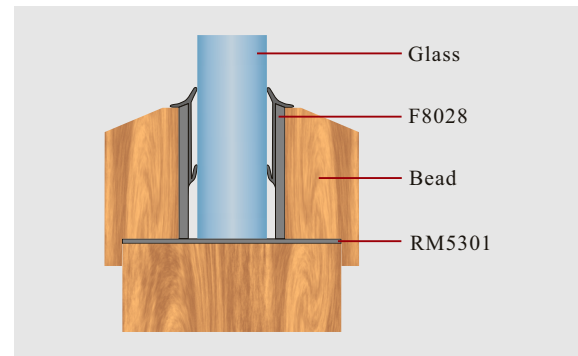
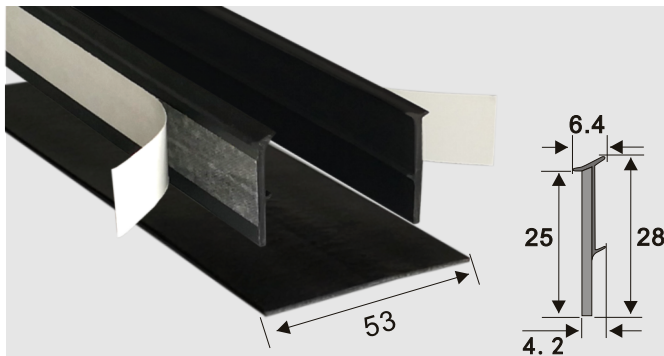
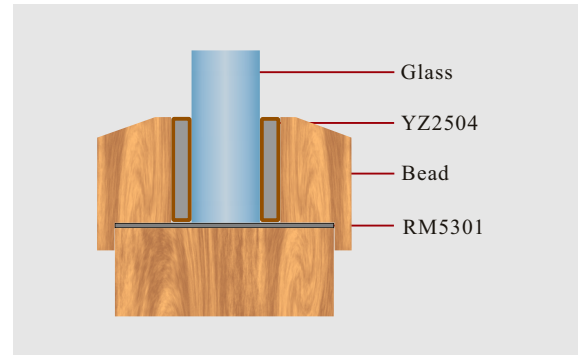
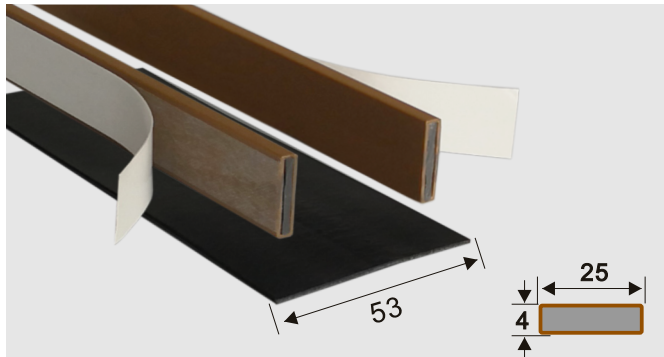

“Galford” 30 minutes fire glazing seal system

- 30 minutes fire glazing seal is designed for 30' glazing system, it is range of U channel strip.
- Suitable for glazed door, partitions and screen.
- Mainly used for 6mm wired glass.
- Easy installation with wrap around glass.

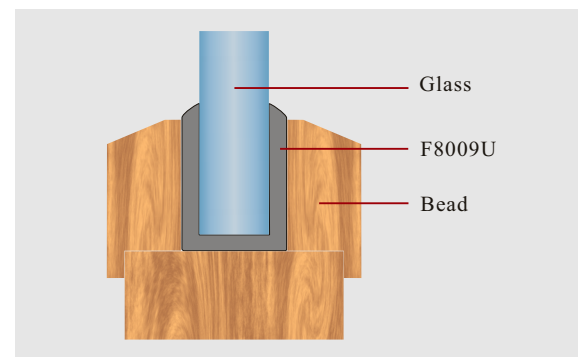
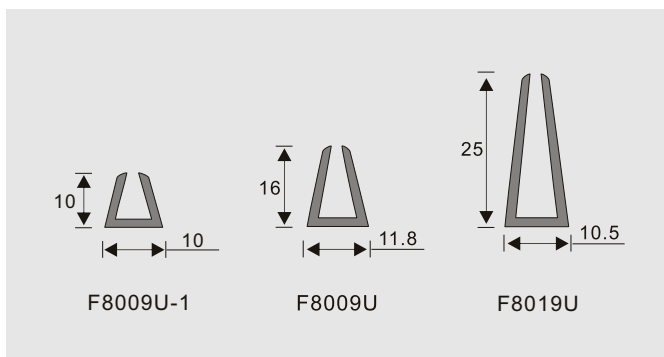

Fire Product

“Gallford” Fire viewer

When temperature goes up to 180°C in fire, the intumescent core inside of door viewer will rapidly expand to filling the interspace to stop fire, smoke or gas through out.

- Material :Available in either brass or chrome finish
- Visual angle: 100-130 degree
- Diameter: 25mm
- FV25-1 suitable for 40-60mm thickness of fire door
- FV25-2 suitable for 60-80mm thickness of fire door
- FV25-3 suitable for 80-100mm thickness of fire door
- Back cover available

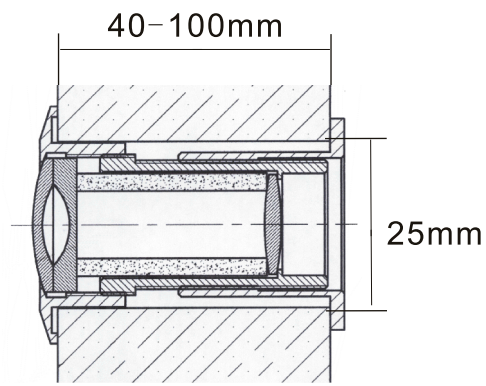

Fire Product

“Gallford”Fire grille

- Fire grille is designed for fireproof doors , it can meets the demand of ventilation in daily life and provide and excellent fire protection through rapid expansion by itself in a fire,thereby prevent passing fire and hot gases.
- Suitable for fire resisting doorsets & compartment walls for up to 60 minute fire resistance.
- Fire grille size: Minimum unit is 150mm*150mm, Horizontal and vertical overlapping, thickness 40mm . standard set is 1 grille+2 face plate

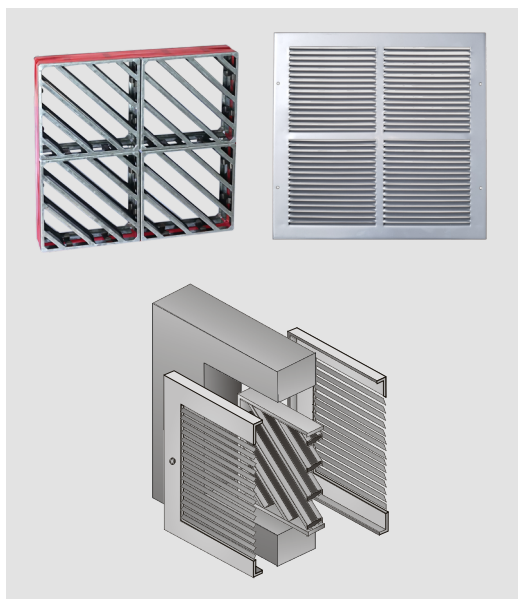

Part Number	Profile Size (mm)	Fire Resistance Time
GF1515	150×150×40	30/60minutes
GF3015	300×150×40	30/60minutes
GF3030	300×300×40	30/60minutes
GF4545	450×450×40	30/60minutes
GF6060	600×600×40	30/60minutes

产品组合示意图;

